

# Inverse Prop. Pressure-Relief Cart., Size 2...4

$Q_{\max} = 24 \text{ l/min (6 gpm)}$ ,  $p_{\max} = 400 \text{ bar (5800 psi)}$   
 Direct acting, electrically operated  
 Series DBDTC-1LG...



- Compact construction for cavity type AL – 3/4-16 UNF
- Operated by a proportional solenoid
- Nominal pressure when solenoid de-energised (fail-safe function)
- 6 pressure ranges available
- All exposed parts with zinc-nickel plating
- High pressure wet-armature solenoids
- The slip-on coil can be rotated, and it can be replaced without opening the hydraulic envelope
- With integral manual pressure setting
- Can be fitted in a line-mounting body

## 1 Description

Series DBDTC-1LG... inverse proportional pressure-relief valves are direct acting screw-in cartridges of sliding-spool design with a falling pressure/current characteristic and a 3/4-16 UNF mounting thread. With these pressure-relief cartridges, the relief pressure is dependent on the electrical control signal and can be continuously varied. When the solenoid is de-energised (initial position), the relief pressure is the nominal pressure of the applicable spring range (fail-safe function). Any pressure at port 1 is additive to the valve setting at port 2, therefore port 1 should preferably be connected directly to tank. In control mode, the relief pressure is inversely proportional to the change in the required value (amplifier output current). In order to obtain precise pressure settings over the whole of the required pressure range

(optimum resolution), the pressure relief cartridges are available in six spring ranges. If a proportional solenoid is faulty, for example, the integral manual pressure setting enables the required pressure to be set mechanically. Inverse proportional pressure-relief cartridges are predominantly used in mobile and industrial applications to allow a pressure in hydraulic installations to be limited electro-proportionally. All external parts of the cartridge are zinc-nickel plated to DIN 50 979 and are thus suitable for use in the harshest operating environments. The slip-on coils can be replaced without opening the hydraulic envelope and can be positioned at any angle through 360°. If you intend to manufacture your own cavities or are designing a line-mounting installation, please refer to the section "Related data sheets".

## 2 Symbol

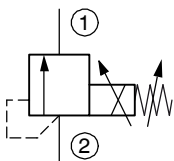

## 3 Technical data

General characteristics	Description, value, unit
Designation	inverse proportional pressure-relief cartridge
Design	direct acting, electrically operated
Mounting method	screw-in cartridge 3/4-16 UNF
Tightening torque	40 Nm ± 10 % (30 ft-lbs ± 10 %)
Size	nominal size 2...4, cavity type AL
Weight	0.58 kg (1.28 lb)

General characteristics	Description, value, unit
Mounting attitude	unrestricted (preferably vertical, coil down)
Ambient temperature range	-25 °C ... +60 °C (77 °F ... +140 °F)
<b>Hydraulic characteristics</b>	
Maximum operating pressure ( $p_{max}$ ) - main port 2 - port 1	400 bar (5800 psi) 250 bar <sup>1)</sup> (3600 psi)
Maximum flow rate	24 l/min <sup>2)</sup> (6 gpm)
Nominal pressure ranges ( $p_N$ )	25 bar, 63 bar, 100 bar, 160 bar, 230 bar, 350 bar (350 psi, 860 psi, 1400 psi, 2300 psi, 3300 psi, 5000 psi)
Leakage flow rate 2 → 1 pressure range 25 / 63 bar (350 / 860 psi) 100 bar (1400 psi) 160 bar (2300 psi) 230 bar (3300 psi) 350 bar (5000 psi)	... 0.10 l/min (0.03 gpm) ... 0.20 l/min (0.05 gpm) ... 0.25 l/min (0.06 gpm) ... 0.30 l/min (0.08 gpm) ... 0.40 l/min (0.1 gpm)
Flow direction	2 → 1 see symbols
Hydraulic fluid	HL and HLP mineral oil to DIN 51 524; for other fluids, please contact BUCHER
Hydraulic fluid temperature range	-25 °C ... +70 °C (-77 °F ... +158 °F)
Viscosity range	15...380 mm <sup>2</sup> /s (cSt), recommended 20...130 mm <sup>2</sup> /s (cSt)
Minimum fluid cleanliness Cleanliness class to ISO 4406 : 1999	class 18/16/13



### ATTENTION!

- 1) To prevent any pressure surges, port 1 must be routed to tank with the least possible back-pressure. Any tank pressure acting at port 1 is additive to the pressure setting at the main port 2.
- 2) Depending on the nominal pressure stage.

Electrical characteristics	Description, value, unit
Supply voltage	12 V DC, 24 V DC
Control current	12 V = 0...1600 mA, 24 V = 0...800 mA
Power consumption at max. control current	max. 17.5 W
Coil resistance R - cold value at 20 °C - max. warm value	12 V = 4.35 Ω / 24 V = 17.2 Ω 12 V = 6.8 Ω / 24 V = 26.9 Ω
Recommended PWM frequency (dither)	200 Hz
Hysteresis with PWM	2...4 % $I_N$
Reversal error with PWM	2...4 % $I_N$
Sensitivity with PWM	< 1 % $I_N$
Reproducibility with PWM	< 2 % $p_N$
Switching time	6 ... 90 ms (Solenoid ON) 6 ... 20 ms (Solenoid OFF) <small>These times are strongly influenced by fluid pressure, flow rate and viscosity, as well as by the dwell time under pressure.</small>
Relative duty cycle	100 %
Protection class to ISO 20 653 / EN 60 529	IP 65 / IP 67 / IP 69K, see "Ordering code" (with appropriate mating connector and proper fitting and sealing)
Electrical connection	DIN EN 175301-803, 3-pin 2 P+E (standard) for other connectors, see "Ordering code"

**4 Performance graphs** measured with oil viscosity 33 mm<sup>2</sup>/s (cSt)

$p = f(I)$  Pressure adjustment characteristic ( $Q = 1$  l/min)

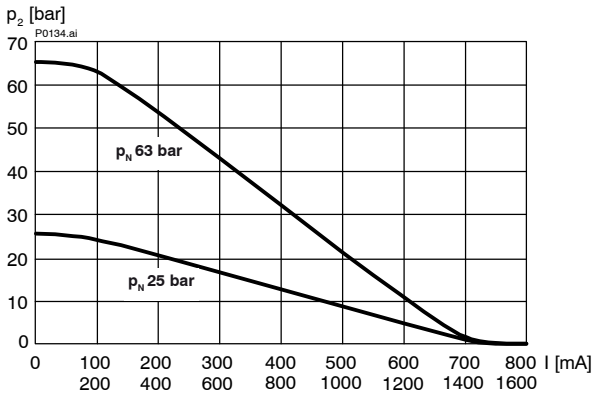

$p = f(I)$  Pressure adjustment characteristic ( $Q = 1$  l/min)

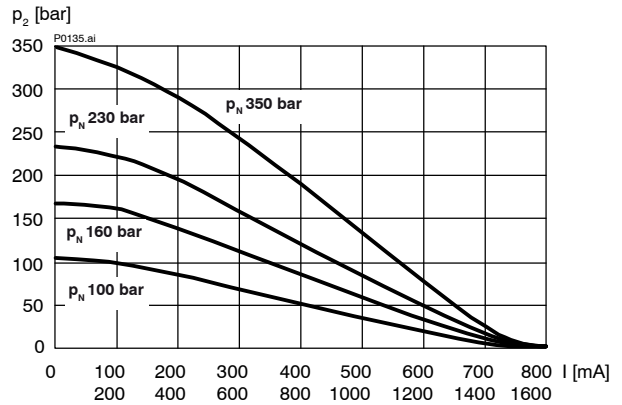

$p = f(Q)$  Pressure - Flow rate characteristic  $p_N = 25$  bar

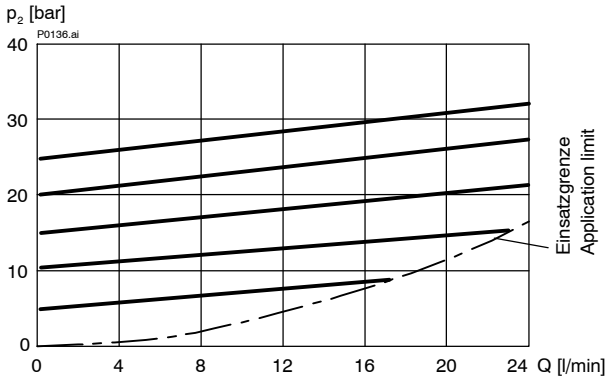

$p = f(Q)$  Pressure - Flow rate characteristic  $p_N = 63$  bar

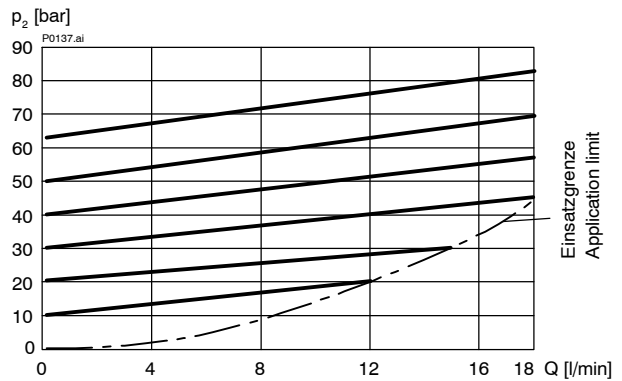

$p = f(Q)$  Pressure - Flow rate characteristic  $p_N = 100$  bar

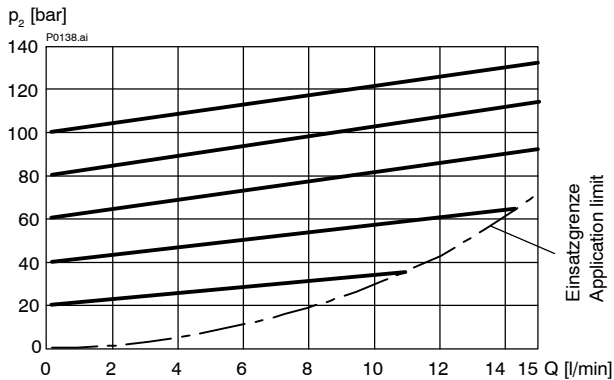

$p = f(Q)$  Pressure - Flow rate characteristic  $p_N = 160$  bar

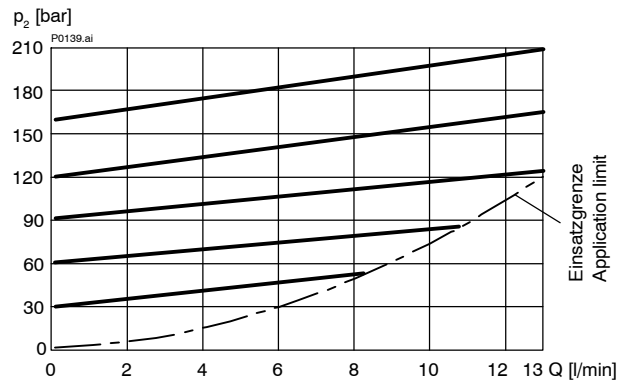

$p = f(Q)$  Pressure - Flow rate characteristic  $p_N = 230$  bar

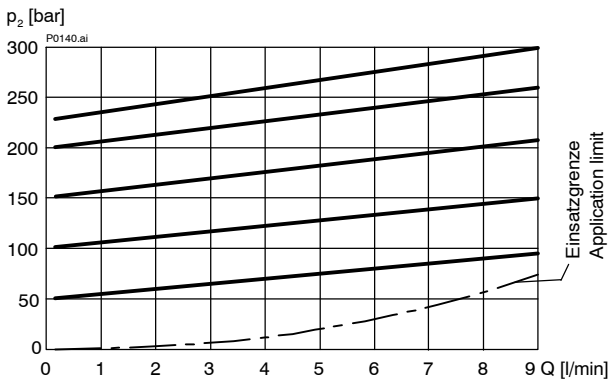

$p = f(Q)$  Pressure - Flow rate characteristic  $p_N = 350$  bar

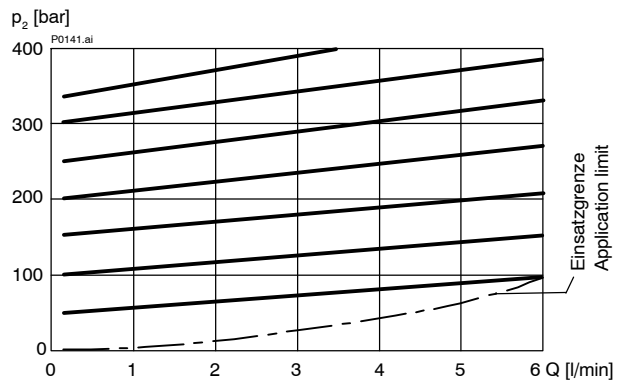

## 5 Dimensions & sectional view

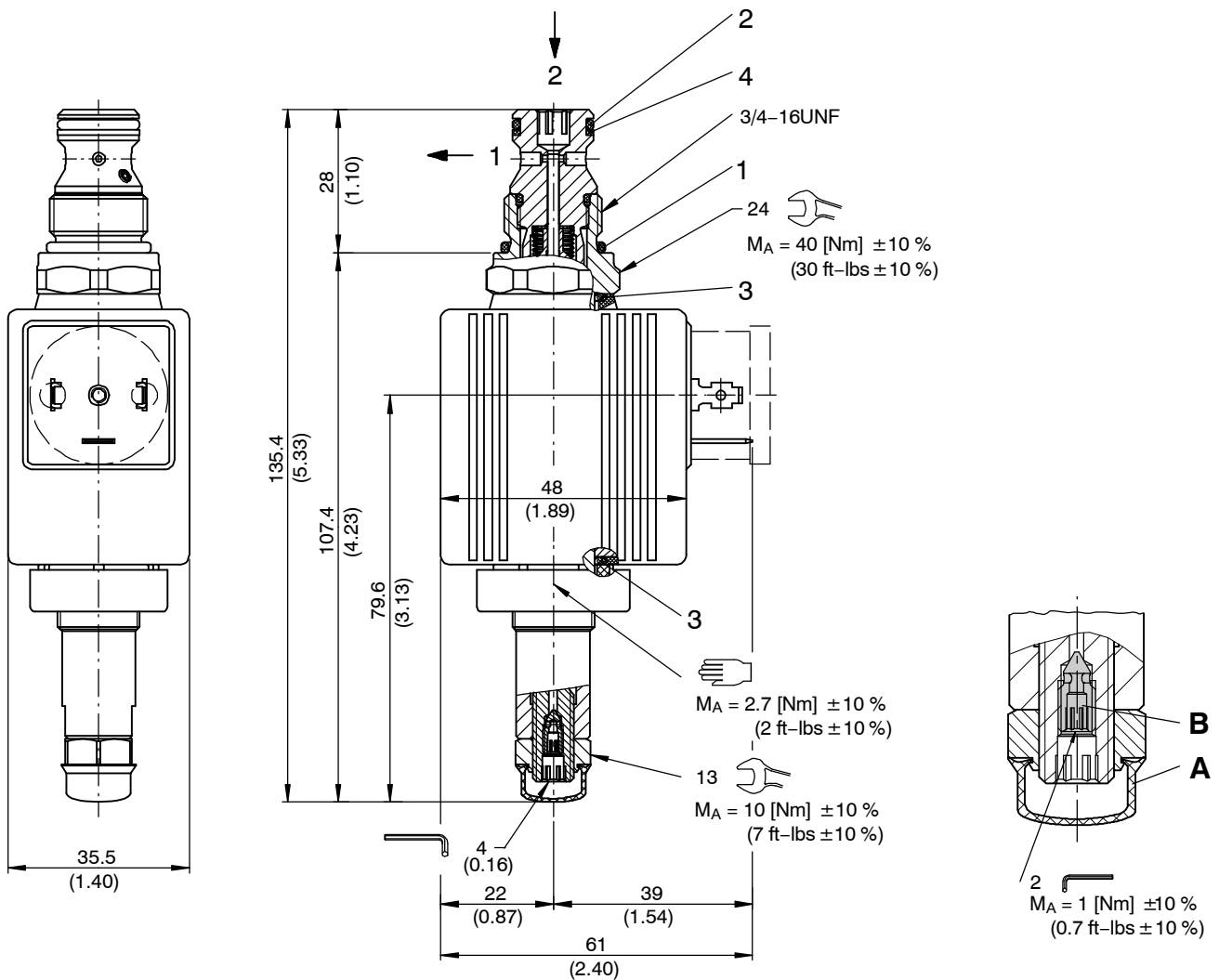

Seal kit NBR no. DS-284-N <sup>1)</sup>

Item	Qty.	Description
1	1	O-ring no. 017 Ø 17.17 x 1.78 N90
2	1	O-ring no. 014 Ø 12.42 x 1.78 N90
3	2	O-ring Ø 16.00 x 2.00 FKM
4	1	Backup ring Ø 10.70 x 1.45 x 1.00 FI0751



### IMPORTANT!

<sup>1)</sup> Seal kit with FKM (Viton) seals no. DS-284-V

### Integral air-bleeding

If necessary, air can be purged from these proportional pressure-relief cartridges by using the integral air-bleed screw (Item B). The procedure is as follows:

- F Protective cap
- G Air-bleed screw

### Steps:

7. Remove the protective cap.
8. Slacken the air-bleed screw approx. 2 turns.
9. Switch the pressure-relief cartridge on/off several times until no more air bubbles escape.
10. Tighten the air-bleed screw (M<sub>A</sub> = 1 Nm ± 10%).
11. Fit the protective cap.

## 6 Installation information



### IMPORTANT!

To achieve the proportional pressure-relief cartridge's maximum performance rating, fit the solenoid coil as shown (plug socket upwards or to screw-in thread). When fitting the cartridges, note the mounting attitude (preferably vertical, with coil down " automatic air bleed) and use the specified tightening torque. No adjustments are necessary, since the cartridges are set in the factory.



### ATTENTION!

To prevent any pressure surges, port 1 must be routed to tank with the least possible back-pressure. Any tank pressure acting at port 1 is additive to the pressure setting at the main port 2.



### ATTENTION!

Only qualified personnel with mechanical skills may carry out any maintenance work. Generally, the only work that should ever be undertaken is to check, and possibly replace, the seals. When changing seals, oil or grease the new seals thoroughly before fitting them.

## 7 Manual pressure setting

The inverse proportional pressure relief cartridges are equipped with emergency pressure adjustment as standard. If the electrical control fails, the preset maximum pressure value is set. This can be lowered mechanically to a desired pressure value. This emergency pressure setting is not intended for pressure value adjustments in solenoid operation.



### IMPORTANT!

Any changes to the emergency pressure setting have a direct effect on the factory settings.

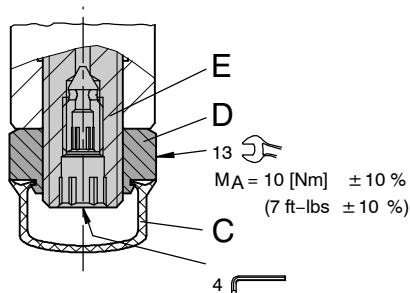

H Protective cap

I Lock nut (13 A/F)

J Adjusting spindle for pressure setting

### Setting the pressure manually

Steps:

1. Remove the protective cap.
2. Slacken the lock nut (13 A/F).
3. Unscrew (turn to left) the adjusting spindle (4 A/F) until the required pressure is set.
4. Tighten the lock nut (13 A/F).
5. Fit the protective cap.



### ATTENTION!

To reset the inverse proportional pressure-relief cartridges to their initial position (the factory setting), a constant flow rate and a pressure gauge that measures the pressure in the main port 2 are needed. The pressure setting must not exceed the nominal pressure of the spring range in use. The procedure is as follows:

### Restoring the factory settings

Steps:

1. Solenoid de-energised.
2. Remove the protective cap.
3. Slacken the lock nut (13 A/F).
4. Unscrew the adjusting spindle (4 A/F) to its end-stop, then screw it in until the pressure on the gauge reaches the nominal pressure ( $p_N$ ) of the spring range in use.
5. Tighten the lock nut (13 A/F).
6. Fit the protective cap.

### 8 Ordering code

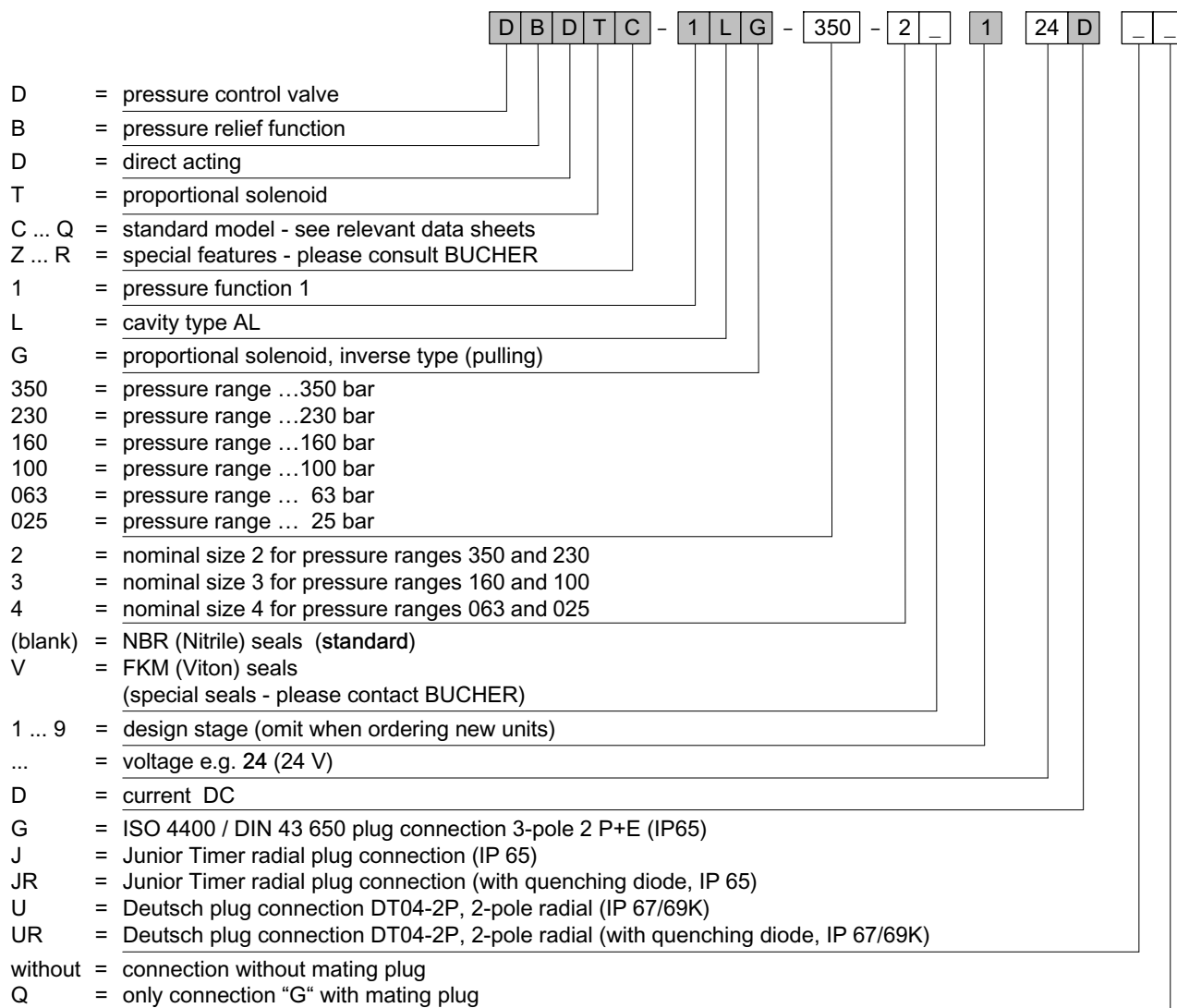

### 9 Related data sheets

Reference	(Old no.)	Description
400-P-040011	(i-32)	The form-tool hire programme
400-P-060171		Cavity type AL
400-P-120212		Coil for solenoid valve, series 36X48/16.1
400-P-510101		Amplifier unit for proportional valves (1-channel) PBS - 3A
400-P-720101		Line-mounting body, type GALA (G 3/4")

info.ch@bucherhydraulics.com

www.bucherhydraulics.com

© 2018 by Bucher Hydraulics AG Frutigen, CH-3714 Frutigen

All rights reserved.

Data is provided for the purpose of product description only, and must not be construed as warranted characteristics in the legal sense. The information does not relieve users from the duty of conducting their own evaluations and tests. Because the products are subject to continual improvement, we reserve the right to amend the product specifications contained in this catalogue.

Classification: 430.305.300.305.305.310