

Prop. 3-Way Pressure-Reducing Cartridge, Size 10

$Q_{\max} = 120 \text{ l/min}$, $p_{\max} = 350 \text{ bar}$
Seated pilot, spool-type main stage
Series DRVSA-7P...



- Compact construction for cavity type DP to ISO 7789-27-09-0-07
- Operated by a proportional solenoid
- 4 pressure ranges available
- Full-flow secondary pressure relief
- External pilot-oil drain
- Excellent stability over the whole pressure and flow range
- All exposed parts with zinc-nickel plating
- High pressure wet-armature solenoids
- The slip-on coil can be rotated, and it can be replaced without opening the hydraulic envelope
- Various plug-connector systems and voltages are available
- Can be fitted in a line-mounting body
- Can be fitted in sandwich bodies

1 Description

Series DRVSA-7P... proportional 3-way pressure-reducing valves are size 10, high performance screw-in cartridges with an M27 x 2 mounting thread. Using the leak-free seat-type pilot cartridge, the secondary pressure in port 1 is dependent on the electrical control signal and it can be continuously varied and set at any desired level. In control mode, the connection 2 → 1 opens until the pressure in port 1 reaches the preset level. If the pressure rises above the preset level, the control spool opens the 1 → 3 connection until balance is attained. These 3-way pressure-reducing cartridges function as full-flow pressure relief valves from port 1 → 3 as soon as the reduced pressure rises above the valve pressure setting. Four spring ranges are available in order to obtain precise pressure settings over the whole of the re-

quired pressure range. To achieve a high degree of functional stability in systems that are susceptible to oscillation, the pilot drain (port 4) must be routed to tank with the least possible back-pressure. These 3-way pressure-reducing cartridges are predominantly used in mobile and industrial applications for reducing a system pressure. All external parts of the cartridge are zinc-nickel plated to DIN 50 979 and are thus suitable for use in the harshest operating environments. The slip-on coils can be replaced without opening the hydraulic envelope and can be positioned at any angle through 360°. If you intend to manufacture your own cavities or are designing a line-mounting installation, please refer to the section "Related data sheets".

2 Symbol

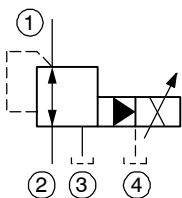

3 Technical data

General characteristics	Description, value, unit
Designation	proportional 3-way pressure-reducing cartridge
Design	seated pilot, spool-type main stage
Mounting method	screw-in cartridge M27 x 2

General characteristics	Description, value, unit
Tightening torque	80 Nm \pm 10 %
Size	nominal size 10, cavity type DP
Weight	0.60 kg
Mounting attitude	unrestricted (preferably vertical, coil down)
Ambient temperature range	-25 °C ... +50 °C

Hydraulic characteristics	Description, value, unit
Maximum operating pressure - ports 1, 2, 3 - port 4	350 bar 250 bar ¹⁾
Maximum flow rate	120 l/min
Nominal pressure ranges	100 bar, 160 bar, 250 bar, 350 bar
Pilot-oil consumption	0.3 ... 0.5 l/min
Flow direction	see symbol
Hydraulic fluid	HL and HLP mineral oil to DIN 51 524; for other fluids, please contact BUCHER
Hydraulic fluid temperature range	-25 °C ... +70 °C
Viscosity range	15...380 mm ² /s (cSt), recommended 20...130 mm ² /s (cSt)
Minimum fluid cleanliness Cleanliness class to ISO 4406 : 1999	class 18/16/13



ATTENTION!

¹⁾ To prevent any pressure surges, port 4 must be routed to tank with the least possible back-pressure.

Electrical characteristics	Description, value, unit
Supply voltage	12 V DC, 24 V DC
Supply voltage tolerance	\pm 10 %
Control current	12 V = 0...1400 mA, 24 V = 0...750 mA
Power consumption at max. control current	max. 19 W
Coil resistance R - cold value at 20 °C - max. warm value	12 V = 5.8 Ω / 24 V = 21 Ω 12 V = 8.6 Ω / 24 V = 32 Ω
Recommended PWM frequency (dither)	200 Hz
Hysteresis with PWM	2...4 % I _N
Reversal error with PWM	1...3 % I _N
Sensitivity with PWM	\leq 1 % I _N
Reproducibility with PWM	< 2 % p _N
Switching time	<i>Pressure-reducing function:</i> 20 ... 29 ms (Solenoid ON) 12 ... 26 ms (Solenoid OFF) <i>Pressure-relief function:</i> 24 ... 62 ms (Solenoid ON) 15 ... 45 ms (Solenoid OFF) The switching times are strongly influenced by flow rate, pressure, viscosity and the dwell period under pressure.
Relative duty cycle	100 %

Electrical characteristics	Description, value, unit
Protection class to ISO 20 653 / EN 60 529	IP 65 / IP 67 / IP 69K, see "Ordering code" (with appropriate mating connector and proper fitting and sealing)
Electrical connection	DIN EN 175301-803, 3-pin 2 P+E (standard) for other connectors, see "Ordering code"

4 Performance graphs

measured with oil viscosity 33 mm²/s (cSt)

$p = f(I)$ Pressure adjustment characteristic

p_1 [bar]

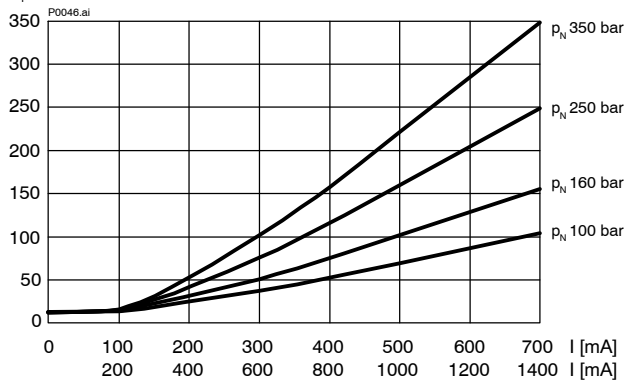

$p = f(Q)$ Pressure - Flow rate characteristic [$p_N = 100$ bar]

p_1 [bar]

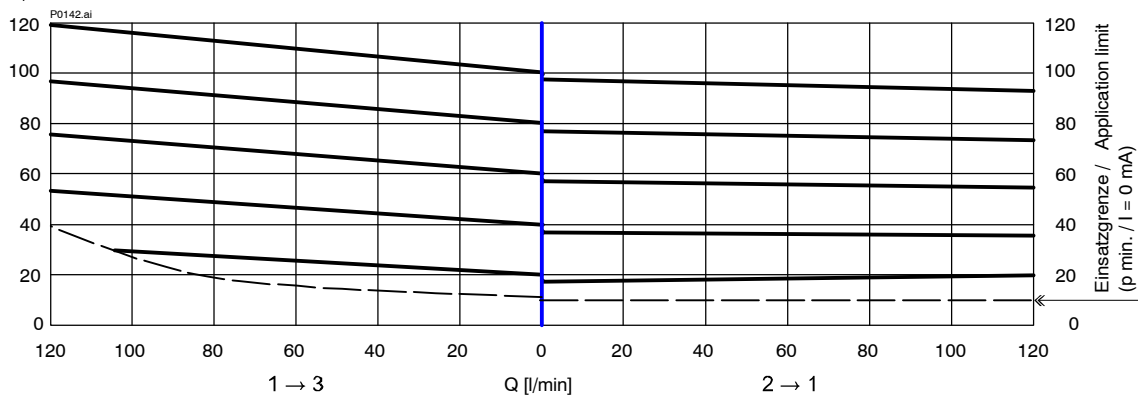

$p = f(Q)$ Pressure - Flow rate characteristic [$p_N = 160 \text{ bar}$]

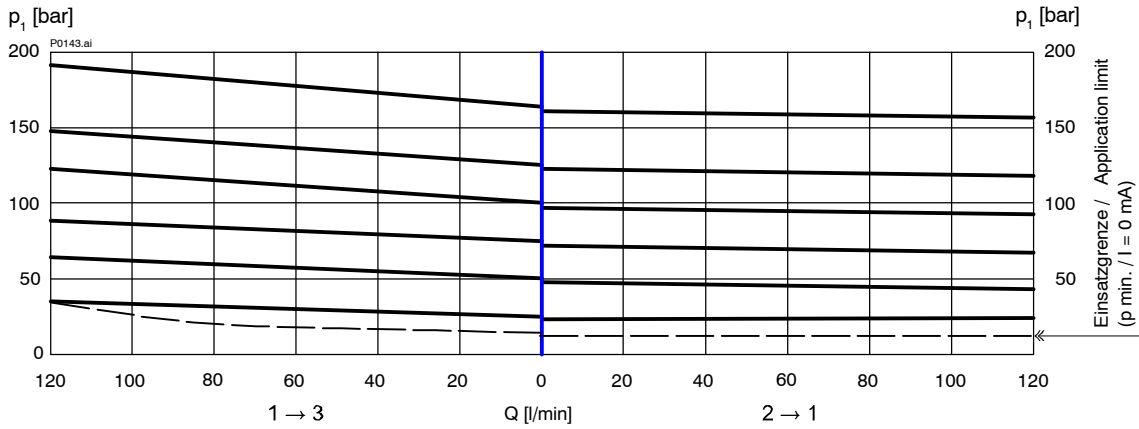

$p = f(Q)$ Pressure - Flow rate characteristic [$p_N = 250 \text{ bar}$]

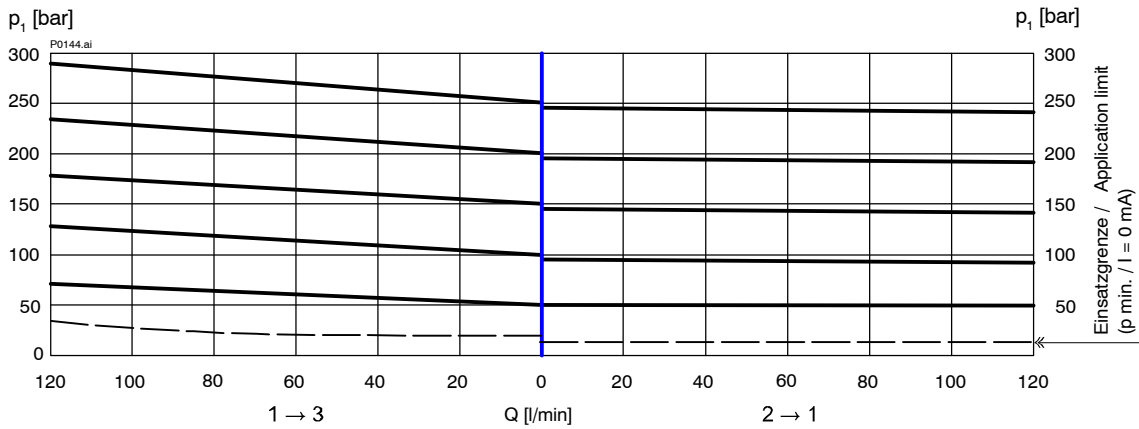

$p = f(Q)$ Pressure - Flow rate characteristic [$p_N = 350 \text{ bar}$]

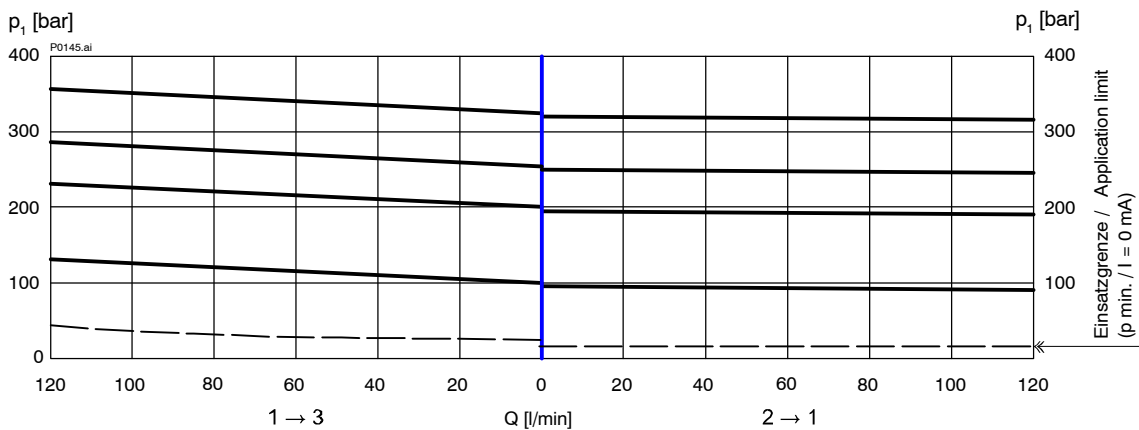

5 Dimensions & sectional view

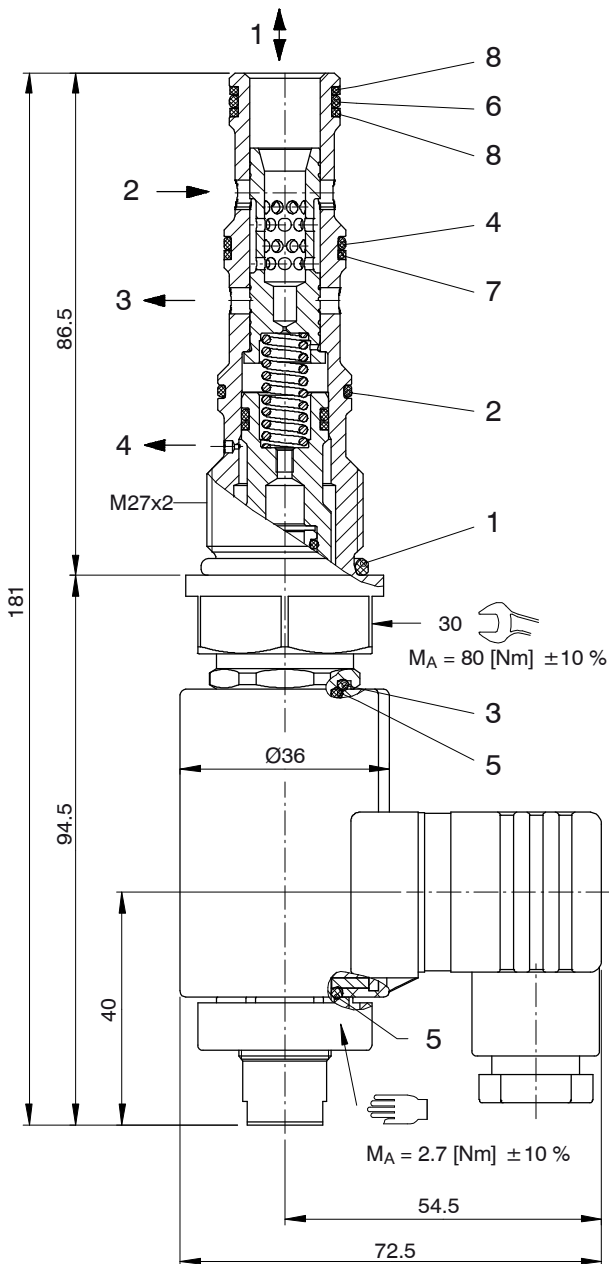

6 Installation information



IMPORTANT!

To achieve the proportional pressure-reducing cartridge's maximum performance rating, fit the solenoid coil as shown (with the plug pins at the bottom). When fitting the cartridges, note the mounting attitude (preferably vertical, with coil down → automatic air bleed) and use the specified tightening torque. No adjustments are necessary, since the cartridges are set in the factory.



ATTENTION!

Only qualified personnel with mechanical skills may carry out any maintenance work. Generally, the only work that should ever be undertaken is to check, and possibly replace, the seals. When changing seals, oil or grease the new seals thoroughly before fitting them.



ATTENTION!

To prevent any pressure surges, port 4 must be routed to tank with the least possible back-pressure.

Seal kit NBR no. DS-394-N ¹⁾

Item	Qty.	Description
1	1	O-ring no. 119 Ø 23,47 x 2,62 N90
2	1	O-ring no. 018 Ø 18,77 x 1,78 N90
3	1	O-ring Ø 18,00 x 2,00 FKM
4	1	O-ring no. 017 Ø 17,17 x 1,78 N90
5	2	O-ring Ø 16,00 x 2,00 FKM
6	1	O-ring no. 016 Ø 15,60 x 1,78 N90
7	1	Backup ring Ø 16,60 x 1,30 x 1,40 FI0751
8	2	Backup ring Ø 14,90 x 1,40 x 1,40 FI0751



IMPORTANT!

¹⁾ Seal kit with FKM (Viton) seals, no. DS-394-V

7 Ordering code

Ex.

DRV	S	A	-	7	P	-	350	-	10	-	2	-	24	D	-
-----	---	---	---	---	---	---	-----	---	----	---	---	---	----	---	---

- DRV = pressure-relief cartridge, two stage
- S = standard solenoid (proportional)
- A ... Q = standard model - see relevant data sheets
- Z ... R = special features - please consult BUCHER
- 7 = 3-way pressure function (external pilot drain)
- P = cavity type DP to ISO 7789-27-09-0-07
- 350 = pressure range ...350 bar
- 250 = pressure range ...250 bar
- 160 = pressure range ...160 bar
- 100 = pressure range ...100 bar
- 10 = nominal size 10
- (blank) = NBR (Nitrile) seals (standard)
- V = FKM (Viton) seals
(special seals - please contact BUCHER)
- 1 ... 9 = design stage (omit when ordering new units)
- ... = voltage e.g. 24 (24 V)
- D = current DC
- (blank) = DIN EN 175301-803 connection with mating plug (standard, IP 65)
- M100 = DIN EN 175301-803 connection without mating plug
- C = Kostal plug connection (IP 65)
- JT = Junior Timer radial plug connection (with protection diode, IP65)
- IT = Junior Timer axial plug connection (with protection diode, IP65)
- D = Deutsch plug connection DT04-2P (IP 67/69K)
- DT = Deutsch plug connection DT04-2P (with protection diode, IP 67/69K)
- S = AMP Superseal 1.5 (IP67) / Metri-Pack 150 (IP65) plug connection
- F = flying leads (500 mm)

} mating plug not supplied

8 Related data sheets

Reference	(Old no.)	Description
400-P-040011	(i-32)	The form-tool hire programme
400-P-060211	(i-45.14)	Cavity type DP
400-P-120110	(W-2.141)	Coils for screw-in cartridge valves
400-P-510101		Amplifier unit for proportional valves (1-channel) PBS - 3A
400-P-511101	(P-3)	Amplifier card, 1-channel for valves with one solenoid, type SAN-535...
400-P-595102		Sandwich prop. 3-way pressure-reducing valve, size 6, type SDRVSA-7...
400-P-596101		Sandwich prop. 3-way pressure-reducing valve, size 10, type SDRVSA-7...
400-P-740171		Line-mounting body, type GCPA (G 1/2")
400-P-740172		Line-mounting body, type GCPAA (G 1/2")

info.ch@bucherhydraulics.com

www.bucherhydraulics.com

© 2017 by Bucher Hydraulics AG Frutigen, CH-3714 Frutigen

All rights reserved.

Data is provided for the purpose of product description only, and must not be construed as warranted characteristics in the legal sense. The information does not relieve users from the duty of conducting their own evaluations and tests. Because the products are subject to continual improvement, we reserve the right to amend the product specifications contained in this catalogue.

Classification: 430.305.305.305.320.310