

## 2/2 ... 4/4 Directional Seat Valve, ISO Size 03

$Q_{\max} = 20 \text{ l/min}$ ,  $p_{\max} = 315 \text{ bar}$

Bidirectional seat-valve shut-off, direct acting, hand operation

Series W2N..., W2P...

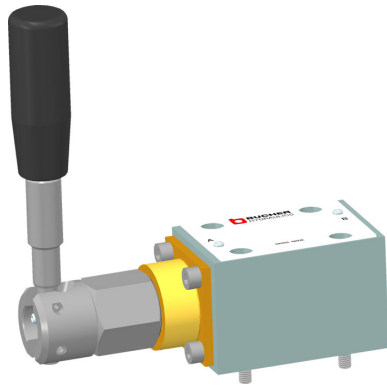

- With cartridge valve, type W1...
- Interface to ISO 4401-03-02
- Bidirectional seat-valve shut-off or flow
- Version with closed crossover (overlap)
- Hand lever with or without detent feature
- With optional push-in check valve or orifice
- External cartridge parts are zinc plated and chromited (CrVI-free)

### 1 Description

The W2N... / W2P... series of 2/2 ... 4/4 hand operated directional seat valves are direct acting, pressure balanced, manifold-mounting valves with a size 03 interface to ISO 4401-03-02. The main components of the valves are a manifold-mounting body and the push-in 2/2 or 3/2 directional seat valve cartridge (type W1...). Dependent on the operating position, the ports are either closed with virtually zero leakage, or open and flow is possible in either direction. The “overlapped” model (W2P...) features a closed crossover characteristic i.e. during the valve’s switching period, there is no connection between the ports and therefore only a minimal loss of flow/pressure occurs. The hand lever can be

turned through 360° and is available as a “detentable” (W2...T/ U/ V...) or “non-detentable” (W2...W / X/ Y...) model. For applications where a check valve or an orifice in the P port is necessary, either of these features can be included as an option. These hand operated seat valves are predominantly used in certain mobile and industrial applications where leak-tight shut-off functions are crucially important. Examples are where loads, tensions, or clamping forces must be held without leakage. The manifold-mounting body is phosphated. All external parts of the cartridge are zinc-nickel plated to DIN 50 979 and are thus suitable for use in the harshest operating environments..

### 2 Technical data

General characteristics	Description, value, unit
Designation	2/2, 3/2, 3/3, 4/3 or 4/4 hand operated directional seat valve
Design	manifold-mounting, bidirectional seat-valve shut-off, direct acting poppet and valve-spool design (pressure balanced) with underlapped or overlapped spool
Mounting method	4 x $\varnothing 5,5$ holes for M5x30 cap screws
Tightening torque	5.2 Nm $\pm$ 10%
Size	size 03 interface to ISO 4401-03-02 / DIN 24 340 A6
Weight	1.45 kg (2/2 ... 3/2 models) 1.90 kg (3/3 ... 4/4 models)
Mounting attitude	unrestricted
Ambient temperature range	-25 °C ... +80 °C

Hydraulic characteristics	Description, value, unit
Maximum operating pressure	...315 bar
Maximum flow rate	20 l/min 10 l/min (series W2P..., with closed crossover)
Flow direction	see symbols, table on page 3
Hydraulic fluid	HL and HLP mineral oil to DIN 51 524; for other fluids, please contact BUCHER
Hydraulic fluid temperature range	-25 °C ... +80 °C
Viscosity range	10...650 mm <sup>2</sup> /s (cSt), recommended 15...250 mm <sup>2</sup> /s (cSt)
Minimum fluid cleanliness Cleanliness class to ISO 4406 : 1999	class 20/18/15

Mechanical characteristics	Description, value, unit
Actuation angle	15°
Mounting attitude	hand lever can be turned through 360°
Design	hand-lever model:       - detentable       W2...T/U/V... - non-detentable   W2...W/X/Y...

### 3 Performance graphs



#### IMPORTANT!

Detailed performance data and other hydraulic characteristics can be found in the data sheet for the respective 2/2 or 3/2 hand operated cartridge seat valve (series W1...) that is fitted. See "Related data sheets".



#### ATTENTION!

The performance figures in the data sheet for the cartridge valve refer just to the cartridge itself. Take into account the additional pressure drop in the body into which it is fitted.

$\Delta p = f(Q)$  Pressure drop - Flow rate characteristic through orifice (metering function)

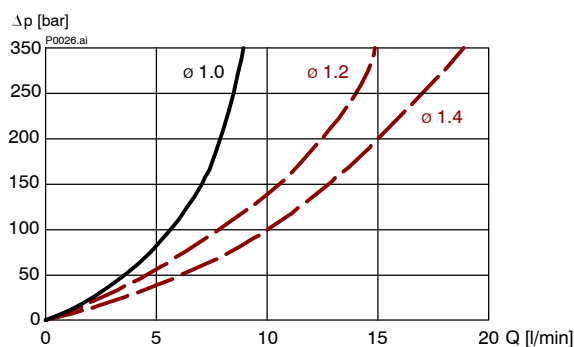

∅ 1.2 and ∅ 1.4 orifices drilled out by customer!

$\Delta p = f(Q)$  Pressure drop - Flow rate characteristic through push-in check valve

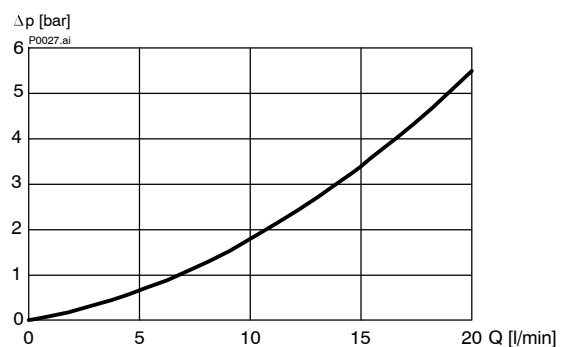

Code	Symbols	Remarks	Operating principle
2-way circuit (with 2/2 cartridge seat valve)	<b>22 S</b> 	For 2/2 circuits, the customer must plug the T port!	
	<b>22 O</b> 	For 2/2 circuits, the customer must plug the P port!	
3-way circuit (with 3/2 cartridge seat valve)	<b>32 S</b> 	For 2/2 circuits, the customer must plug the T port!	
	<b>32 O</b> 	For 2/2 circuits, the customer must plug the T port!	
<b>33 R</b> 	To achieve the 4th valve function (the shaded box), actuate the two hand levers a and b simultaneously!		
4-way circuit (with 3/2 cartridge seat valves)	<b>43 F</b> 	To achieve the 4th valve function (the shaded box), actuate the two hand levers a and b simultaneously!	
	<b>43 G</b> 	To achieve the 4th valve function (the shaded box), actuate the two hand levers a and b simultaneously!	
	<b>44 A</b> 	To achieve the 4th valve function (the shaded box), actuate the two hand levers a and b simultaneously!	

## 4 Dimensions & sectional view

2/2 and 3/2 hand operated directional seat valve (single-hand lever model)

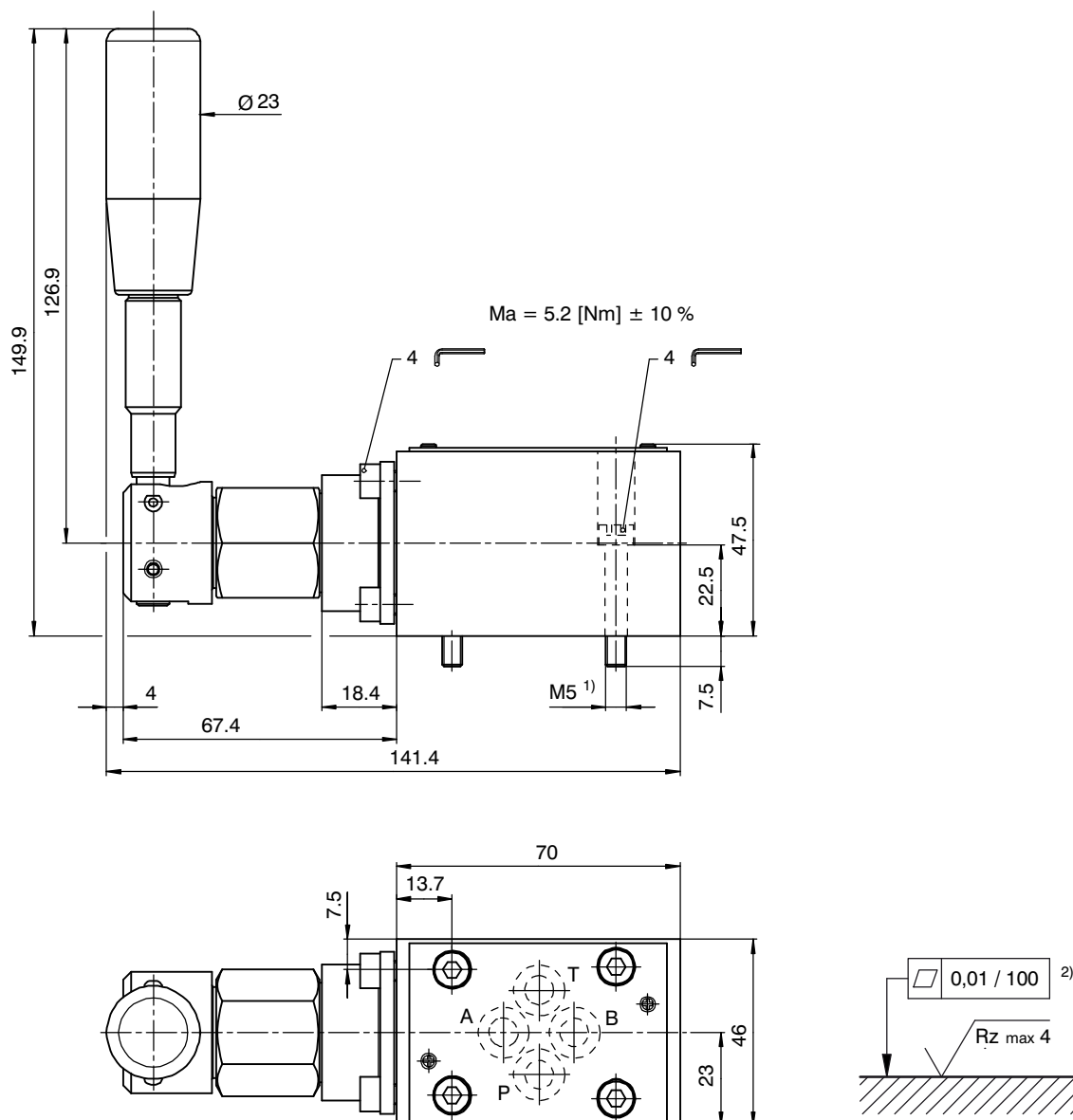

3/3, 4/3, and 4/4 hand operated directional seat valve (double-hand lever model)

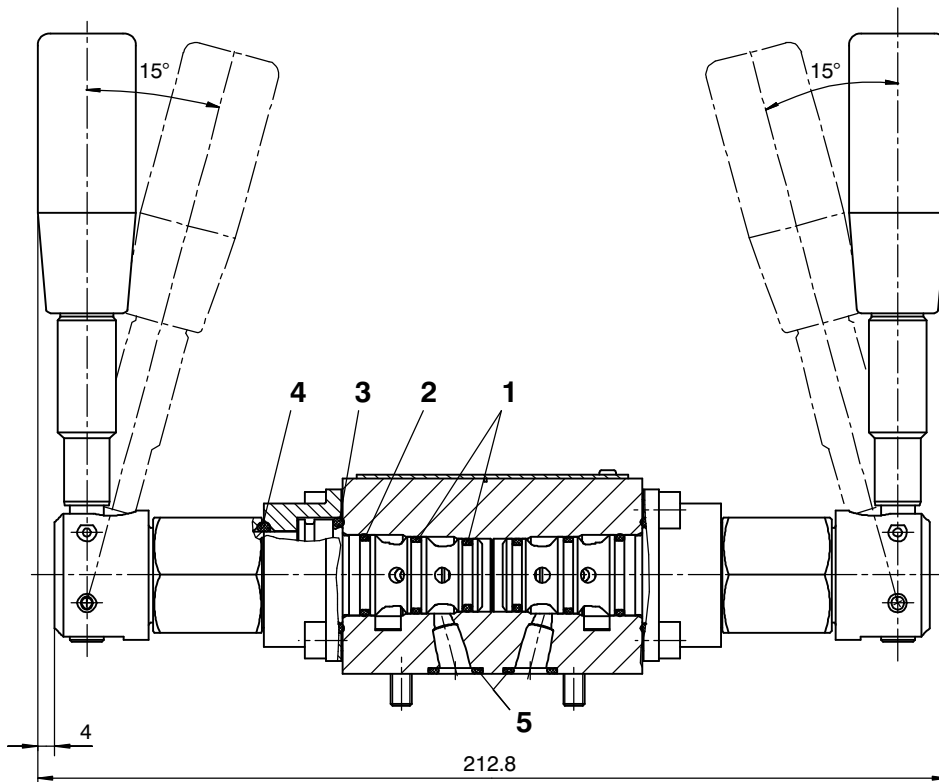

Seal kit NBR no. DS-388-N <sup>3)</sup>

Item	Qty.	Description
1	4	O-ring no. 015 $\varnothing$ 14,00 x 1,78 N90
2	2	O-ring no. 016 $\varnothing$ 15,60 x 1,78 N90
3	2	O-ring no. 021 $\varnothing$ 23,52 x 1,78 N90
4	2	O-ring no. 117 $\varnothing$ 20,29 x 2,62 N70
5	4	O-ring no. 012 $\varnothing$ 9,25 x 1,78 N90



### IMPORTANT!

- 1) Valve mounting bolts M5x30 (included in the delivery)
- 2) Required surface finish on the mounting face (valve pad)
- 3) Seal kit with FKM (Viton) seals, no. DS-388-V

### 5 Options

#### 5.1 Push-in check valve

To prevent uncontrolled back-pressure effects or back-flow of oil, series W2N... / W2P... hand operated directional seat valves can be supplied with an optional push-in check valve, type RCA-5, and a special body. The check valve allows free flow from P to A or B, but prevents flow in the opposite direction, with no leakage.

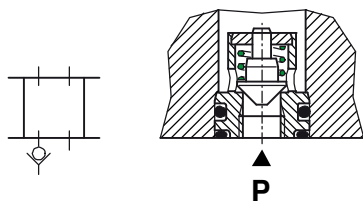

**Application:** when several valves are supplied in parallel, for instance, and the supply pressure in P drops below the pressure in A or B (another circuit is vented, or a lightly-loaded actuator is operated). The pressure in service line A or B is then higher, but the check valve prevents it from falling during such operations in other circuits.

#### 5.2 Orifice (metering function)

An orifice disc (type D10,  $\varnothing$  1.0 mm) must be used when, as a consequence of the operating conditions that exist, circuit operations may result in flow rates that exceed the performance limit of the valve.



#### IMPORTANT!

The orifice disc fitted for this purpose is  $\varnothing$  1.0 mm. Customers may drill it out to  $\varnothing$  1.4 mm maximum (see performance graphs).

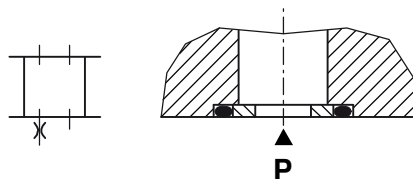

**Application:** when used for charging accumulators, for instance, or when the hand operated directional seat valves are used to pilot other valves.

### 6 Installation information



#### ATTENTION!

Only qualified personnel with mechanical skills may carry out any maintenance work. Generally, the only work that should ever be undertaken is to check, and possibly replace, the seals. When changing seals, oil or grease the new seals thoroughly before fitting them.



#### IMPORTANT!

When fitting the valves, use the specified tightening torque for the mounting bolts. No adjustments are necessary, since the cartridges are set in the factory.

## 7 Ordering code

	Ex.	W2	N	32S	N	6	U	A	B	_
W2	=	directional seat valve, manifold mtg.								
N	=	open crossover (standard)								
P	=	closed crossover, (only possible with 3/2, 4/3, and 4/4 functions)								
22 S	=	2/2 function, P closed								
22 O	=	2/2 function, P ↔ A connected								
32 S	=	3/2 function, P closed								
32 O	=	3/2 function, P ↔ A connected								
33 R	=	3/3 function, P, A and T closed								
43 F	=	4/3 function, P ↔ A ↔ B connected								
43 G	=	4/3 function, A ↔ B ↔ T connected								
44 A	=	4/4 function, P ↔ A and B ↔ T connected								
N	=	without push-in check valve or orifice (standard)								
R	=	with push-in check valve, type RCA-5 (in P port)								
D10	=	with orifice disc, type D10 (in P port)								
6	=	ISO size 03 interface								
T	=	2/2 and 3/3 function, with hand lever, detentable								
W	=	2/2 and 3/3 function, with hand lever, non-detentable								
U	=	3/2, 4/3 and 4/4 function, with hand lever, detentable								
V	=	3/2, 4/3 and 4/4 function, with hand lever, detentable, with closed crossover								
X	=	3/2, 4/3 and 4/4 function, with hand lever, non-detentable								
Y	=	3/2, 4/3 and 4/4 function, with hand lever, non-detentable, with closed crossover								
A ... Q	=	standard model - see relevant data sheets								
Z ... R	=	special features - please consult BUCHER								
B	=	nitrile seals (standard)								
G	=	viton seals								
1 ... 9	=	design number, seat valve (omit when ordering new units)								

## 8 Related data sheets

Reference	(Old no.)	Description
400-P-010301	(i-01)	Orifice flow chart
400-P-030501	(i-31)	Size 03 interface to ISO 4401-03-02
400-P-110310		2/2 cartridge seat valve, series W1T.../ W1W..., size 6
400-P-110315		3/2 cartridge seat valve, series W1U / W1X / W1V / W1Y..., size 6

info.ch@bucherhydraulics.com

www.bucherhydraulics.com

© 2015 by Bucher Hydraulics AG Frutigen, CH-3714 Frutigen

All rights reserved.

Data is provided for the purpose of product description only, and must not be construed as warranted characteristics in the legal sense. The information does not relieve users from the duty of conducting their own evaluations and tests. Because the products are subject to continual improvement, we reserve the right to amend the product specifications contained in this catalogue.

Classification: 430.300.-.315.315.355